

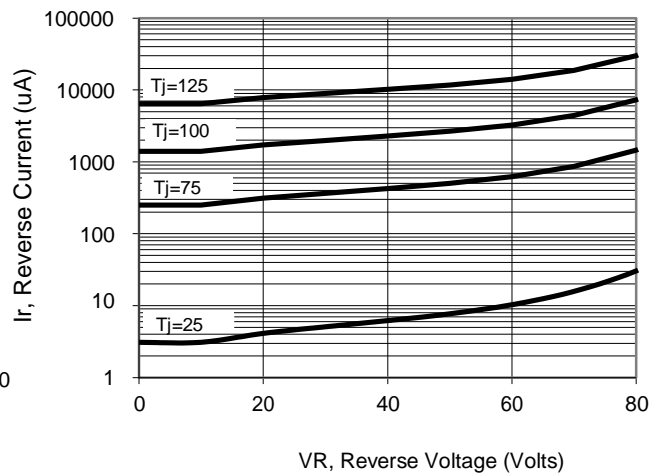

## RATINGS AND CHARACTERISTICS CURVES (TA = 25 °C unless otherwise noted)

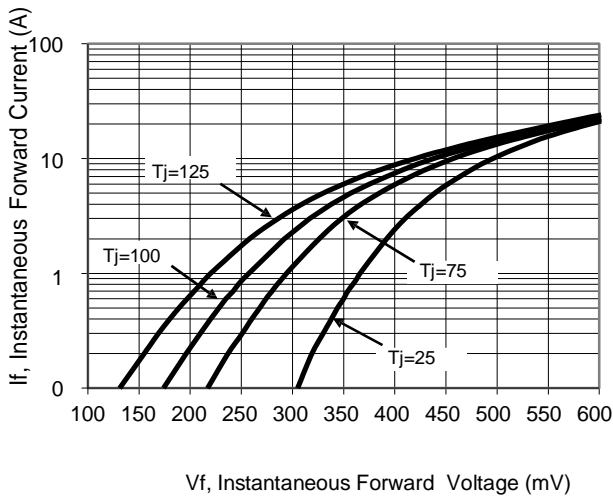

## PACKAGE OUTLINE DIMENSIONS

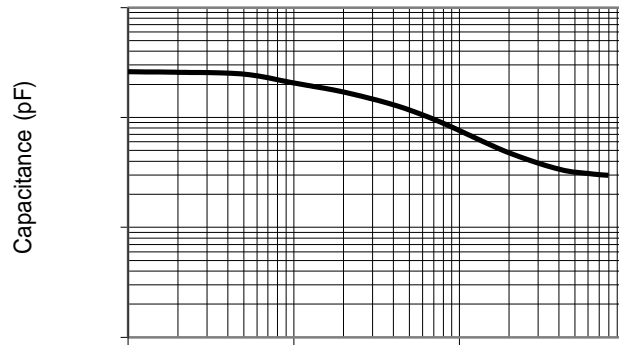
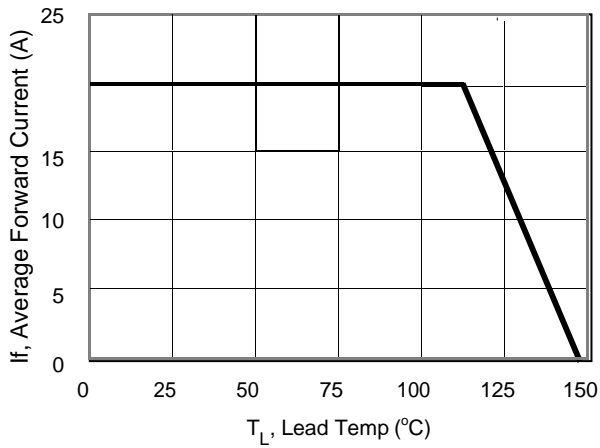
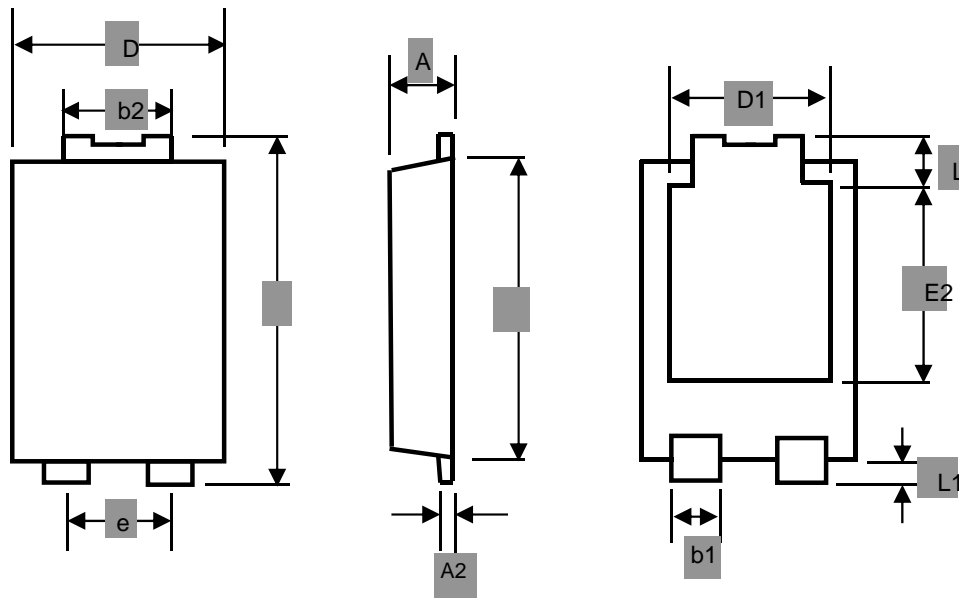

### TO-277 mechanical data

UNIT		A	A2	b1	b2	D	D1	E	E1	E2	L	L1
mm	max	1.3	0.4	1.0	1.9	4.3	3.05	6.6	5.75	3.55	1.0	0.7
	min	1.1	0.2	0.8	1.7	3.9		6.4	5.3		0.8	0.5
mil	max	51.18	15.75	39.37	74.80	169.3	120.0	259.8	226.3	139.7	39.37	27.55
	min	43.30	7.87	31.49	66.93	153.5		252.0	208.6		31.49	19.69

### Suggested Pad Layout

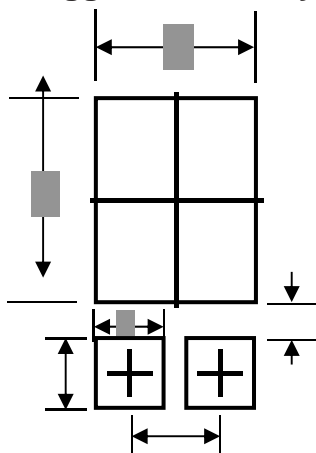

UNIT		C	G	X	X1		
mm	min	1.80	0.90	3.4	1.4		
mil	min	78.86	35.43	133.86	35.43		

## Marking Information

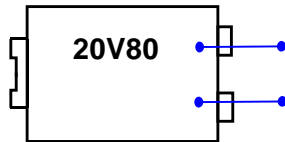

Product model :TSP20V80SP Referred to as 20V80

PDC information

Y X WW

WW:Week code(01 to 53)

X:Internal identification code

Y:Year code(ex:0=2020)

## Packaging Information

### 1.Reel Dimensions

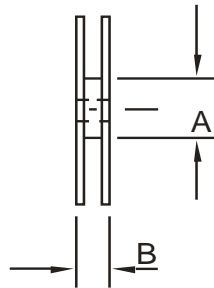
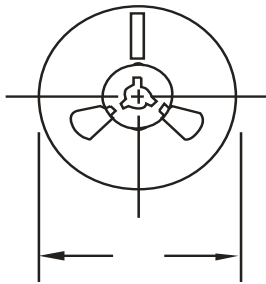

### 2.Inside Box

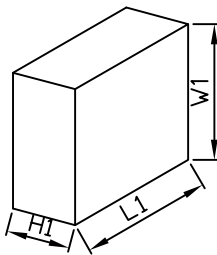

### 3.Outside Box

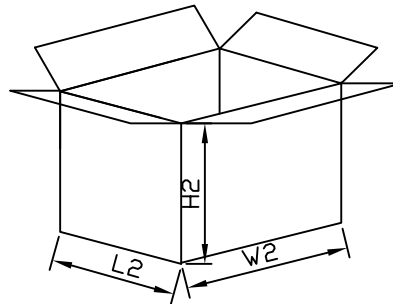

## Packaging Information

NO	UNIT	Reel Dimensions			Inside Box			Outside Box		
			A	B	L1	W1	H1	L2	W2	H2
Size	mm	330	70	15	335	335	43	360	360	360
QTY	PCS	Smallest package,5000PCS/reel			10,000PCS,2 reel in total			80,000PCS/carton,8 boxes in total		
Note	Tolerance 20mm,±3mm; 21-100mm,±5mm; 101-500mm,±10mm									