

8OWUDVRIW 5HFRYHU\ %ULGJH

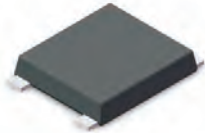

3, 11, 1* /6% 3DFNDJH

3, 1	'(6&5,37,21
	, QSXWÄÄ Q
	, QSXWÄÄ Q
	2XWSXWÄÄ Q RGH
	2XWSXWÄÄ W KRGH

) HDWXUHV
 ‡* OD V V V L Y & W L X G F W L R Q
 ‡5 HYH U R O W D J H 9
 ‡) R U Z D U G U H G W
 ‡+ L J K X U & X U U H Q W D E L O L W \
 ‡' H V L J Q R G X U I D R X G S S O L F D W L R Q

% H Q H I L W V
 ‡ & D V H %
 ‡ 7 H U P L G R O G H U B B O H 6 7 '
 ‡ 5 H G X F H G (0 , 5 H G X F H G S R Z H U
 D Q G V Z L W F K L Q J W U D Q V L V W

0D[LPXP DWL Q Q G O H F W E K B D O F W H U L V W L F V

5DWLQVf & DP EL MGHV SHUXQVUMK H U Z L H F L I L H G
 6LQJOH SKDVH K Q Q I H Z D V M U Q G X F O R D Y H S D F L W E X H U G R D G W H

3DUDPHWHU	6\PEROV	: 5 / 6 % 0	8QLWV
0D[LPXP 5HSHWLWLYH 3HDN 59550U	VH 9ROWDJH		9
0D[LPXP 506 YROWDJH	9506		9
0D[LPXP '& %ORFNLQJ 9ROWDJH &			9
\$YHUDJH 5HFWLILHG 2XWSXW & R U U H Q W			\$
5HYHUVH 5HFRYHU\ 7LPH ,) \$, 5 \$, 55 \$	7UU		XV
3HDN)RUZDUG 6XUJH & XUUH Q W +DOI 6LQH :DYH 6XSHULPSRV, H 60 R Q 5DWHG /RDG -('(& 0HWKRG		PV 6LQJOH R Q 5DWHG	\$
, WUDWIR O X V L Q B V W P V	, W		\$ 6
0D[LPX)RUZ D U R G W D W H \$	9)		9
0D[LPXP '& 5HYHUVH & XUUH Q W # 7 \$ DW 5DWHG '& %ORFNLQJ 9ROWDJH # 7 \$	f & f &		\$
7\SLFDO -XQFWLRQ & R D V D F L W D Q M H			S)
2SHUDWLQJ DQG 6WRUDJH 7H P S T W D W X U H 5 D Q J H a			f &
7\SLFDO WKHUPDO UHVLVWDQJ 5 W K 1 \$ 5 W K 1 \$			f & :
1RWH0HDVX D M G +] D Q G S S O L H H Y H Y R O V R D J H & 0RXQWHG RQ JODVV HSR\ \ 3 & ERDUG ZLW F P R S S H U S D G			

RATINGS AND CHARACTERISTICS CURVES 7\$ ° & XQOHVV RWKHUZZLVH QRWHG

7 F & DVH 7&HPS

Current Derating, Case

3 \$ & . \$ * (287 / , 1 (' , 0 (16 , 2 16

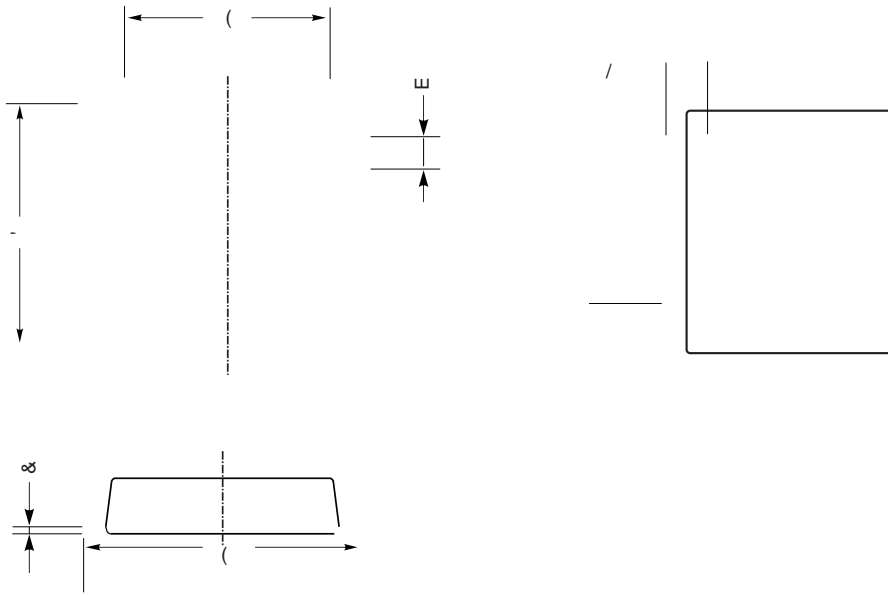

/ 6 % P H F K D Q G L F W D

8 1 , 7		\$	&	'	(&	/	H	E
PP	PD[
	PLQ								
PLO	PD[
	PLQ								

/ 6 % 6 X J J H V W H G 3 D G / D \ R X W

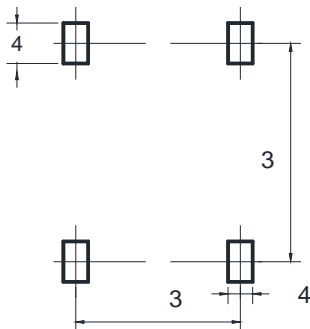

8 1 , 7		3	3	4	4
PP	PLQ				
PLO	PLQ				

' L P H Q V I L R / Q R / L O O L P H W H U V

0DUNLQJ ,QIRUPDWLRQ

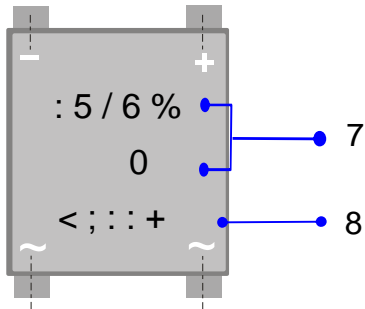

73URGXFW P5R 6% 00
83' & LQIRUPDWLRQ

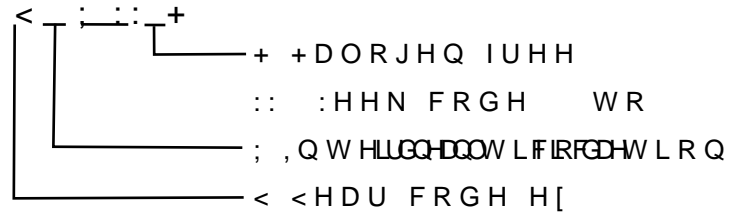

3DFNDJLQJ ,QIRUPDWLRQ

5HHO 'LPHQVLRQV

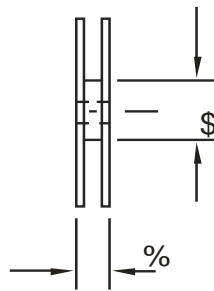
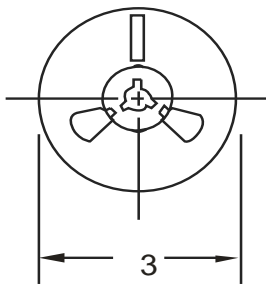

,QVLGH %R[

2XWVLGH %R[

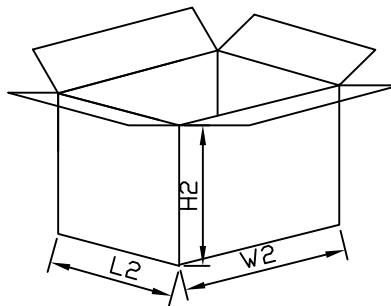
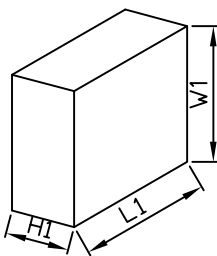

3DFNDJLQJ ,QIRUPDWLRQ

12	81,	5HHO 'LPHQVLR			,QVLGH %R[2XWVLGH %R[
6L]H	PP	&	\$	%	/	:	+	/	:	+
47<	3&6	6PDOGHVFDJH3&6 UHHO			3&6 UHHO RWDO			3&6 FDUERPRQ RWDO		
1RWH		7ROHUDQFH PP" PP			PP" PP			PP" PP		